

Hi-MO 6

Explorer

LR5-54HTB 410~430M

- Suitable for Distribution Market
- Pure black for extreme elegance
- Better energy generation performance
- High-quality module guarantees long-term reliability



25-year Warranty for
Materials and Processing



25-year Warranty for Extra
Linear Power Output

Complete System and Product Certifications

IEC 61215, IEC 61730, UL 61730

ISO9001:2015: ISO Quality Management System

ISO14001: 2015: ISO Environment Management System

ISO45001: 2018: Occupational Health and Safety

IEC62941: Guideline for module design qualification and type approval

LONGI



22.0%
MAX MODULE
EFFICIENCY

0~3%
POWER
TOLERANCE

<1.5%
FIRST YEAR
POWER DEGRADATION

0.40%
YEAR 2-25
POWER DEGRADATION

Additional Value

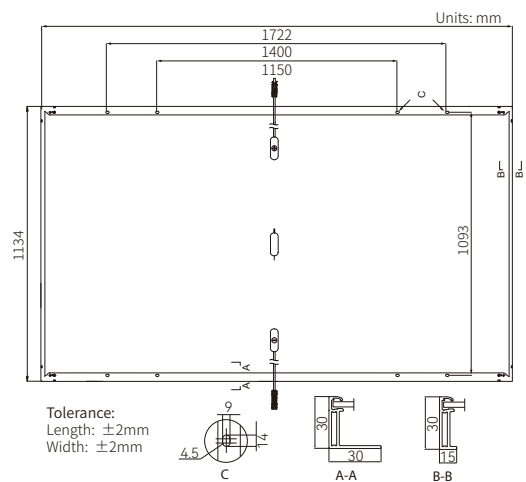
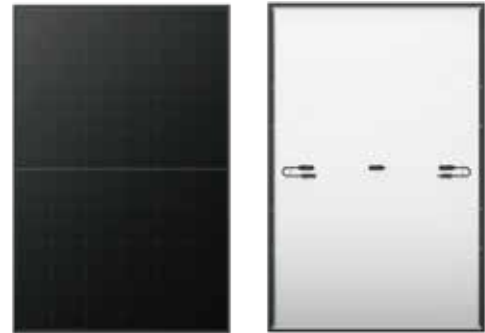
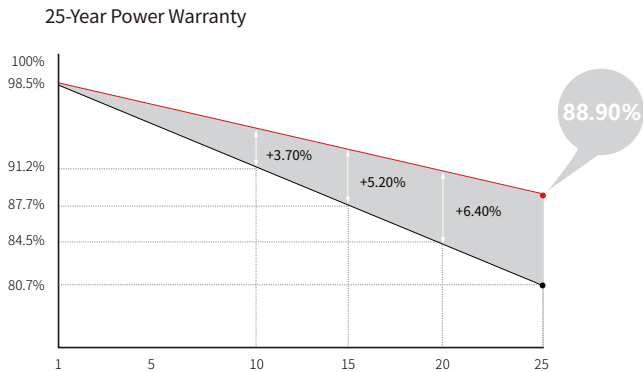

Mechanical Parameters

Cell Orientation	108 (6×18)
Junction Box	IP68
Output Cable	4mm ² , ± 1200 mm length can be customized
Glass	Single glass, 3.2mm coated tempered glass
Frame	Anodized aluminum alloy frame
Weight	20.8kg
Dimension	1722×1134×30mm
Packaging	36pcs per pallet / 216pcs per 20' GP / 936pcs per 40' HC

Electrical Characteristics

STC : AM1.5 1000W/m² 25°C NOCT : AM1.5 800W/m² 20°C 1m/s Test uncertainty for Pmax: $\pm 3\%$

Module Type	LR5-54HTB-410M		LR5-54HTB-415M		LR5-54HTB-420M		LR5-54HTB-425M		LR5-54HTB-430M	
	STC	NOCT	STC	NOCT	STC	NOCT	STC	NOCT	STC	NOCT
Maximum Power (Pmax/W)	410	306	415	310	420	314	425	318	430	321
Open Circuit Voltage (Voc/V)	38.63	36.27	38.83	36.46	39.03	36.65	39.23	36.83	39.43	37.02
Short Circuit Current (Isc/A)	13.70	11.07	13.78	11.13	13.85	11.19	13.93	11.25	14.00	11.31
Voltage at Maximum Power (Vmp/V)	32.36	29.53	32.56	29.71	32.76	29.89	32.96	30.08	33.16	30.26
Current at Maximum Power (Imp/A)	12.67	10.37	12.75	10.44	12.83	10.50	12.90	10.56	12.97	10.62
Module Efficiency(%)	21.0		21.3		21.5		21.8		22.0	

Operating Parameters

Operational Temperature	-40°C ~ +85°C
Power Output Tolerance	0 ~ 3%
Voc and Isc Tolerance	$\pm 3\%$
Maximum System Voltage	DC1500V (IEC/UL)
Maximum Series Fuse Rating	25A
Nominal Operating Cell Temperature	45 ± 2 °C
Protection Class	Class II
Fire Rating	UL type 1 or 2 IEC Class C

Mechanical Loading

Front Side Maximum Static Loading	5400Pa
Rear Side Maximum Static Loading	2400Pa
Hailstone Test	25mm Hailstone at the speed of 23m/s

Temperature Ratings (STC)

Temperature Coefficient of Isc	+0.050%/°C
Temperature Coefficient of Voc	-0.230%/°C
Temperature Coefficient of Pmax	-0.290%/°C